



# Domestic Commercial Vessel INSTRUCTIONS TO SURVEYORS

DCV-ITS-015 (05/2019)

**Subject:** This instruction provides general guidance about the requirements for Extra Low Voltage (ELV) electrical systems onboard new Domestic Commercial Vessels (DCVs).

**General:** ELV is defined as <50 Volts a.c. and < 120 V d.c. A vessel fitted with any of the following is not within the scope of this ITS:

- a. any Low Voltage (LV) wiring;
- b. any High Voltage (HV) wiring;
- c. an inverter (including single outlet inverters supplied by a d.c. accessory outlet);
- d. any mains shore power supply;
- e. any standalone generator set;
- f. any solar systems; and
- g. any non-lead acid batteries.

If any of a to f are fitted or connected to the vessel this will require a Certificate of Compliance supplied by a competent person, for example an electrical surveyor with the appropriate category of accreditation or a licensed electrical contractor.

Boats with inboard petrol engines pose an increased risk and extra measures need to be followed to ensure the safety of the operator and vessel. These measures include the correct selection of electric bilge pump, engine room ventilation and flammable gas sensing equipment.

**Vessel requirements - electrical compliance:**

A person who designs, constructs, maintains, repairs or modifies an ELV electrical system of a DCV must be satisfied that the ELV electrical system is designed, installed and constructed so that it is safe and fit for purpose. Section 14 of the *Marine Safety (Domestic Commercial Vessel) National Law Act 2012* (National Law) imposes duties in that regard on persons that design, construct, repair or modify a DCV.

The surveyor/installer should ensure that the installation is installed in accordance with the standards that apply to the vessel:

- **National Standard of Commercial Vessels, Part C5B, Design and Construction, Electrical**
- **The relevant requirements of AS/NZS 3000:2007 Wiring Rules 2007 (including all amendments and standards referenced within)**
- **AS/NZS 3004.2 Electrical Installations Marinas and boats. Part 2: Boat installations**

In all ELV installations the following should be taken into consideration:

- Wiring must be an appropriate size to minimise voltage drop as specified within AS3000.
- Suitable alternate means to start the engines.
- Fault current issues are correctly addressed.
- Sufficient engine starting battery capacity and adequate power capacity for fitted equipment.
- Appropriate battery isolation, switching and charging arrangements.
- No sources of ignition close to batteries.
- Overcurrent protection.
- Appropriate conductor types and sizes.
- Protection against physical damage to wiring and equipment.
- Accessibility and serviceability of equipment.
- No connections within the bilge.

- Wire/cable should be clearly labelled at both ends and a wiring diagram should be available to aid in fault finding.
- Each circuit should have an independent negative cable, and all these negative cables should eventually be tied back to a common negative point/bus bar which is connected to the battery negative. The negative bus, connected to the battery negative will help to minimize the occurrence of stray currents.
- Wires/cables appropriately supported to prevent damage to the conductors. (Industry best practice would be to use tinned wiring)
- Conductor colours shall follow AS/NZS 3000-2007-3.8 wiring rules guidance.
- All conductors in cables shall be of stranded, annealed copper, constructed in accordance with AS/NZS 1125.

**Wire/Cable selection guide:**

A common mistake on an ELV vessel installation is the incorrect selection of an appropriate wire/cable size for the application. If the incorrect wire size is selected the equipment being supplied may not operate correctly. The wire/cable may overheat, and in the worst case a fire may occur.

Selection of wire/cable size should take into consideration the:

1. length of the cable run (out and back);
2. wire/cable size; and
3. current draw of the equipment, displayed on the equipment specification sheet.

Always refer to product recommendations, or check with your supplier for the appropriate size wire/cable that is required for your particular installation.

The longer the wire/cable run, or the higher the amperage, the larger the cable must be to avoid unacceptable voltage losses. If the current draw is close to the limits of the selected wire/cable, then selection of the next size wire/cable should be considered. This is because the electrical equipment may actually use more current than what it is rated for because of heat, low voltage, extra load and other factors.

On the cable sizing selection chart (provided below), which is designed for 12 Volt systems, there are two types of circuits, Critical and Non Critical. For Critical circuits, the allowed voltage drop is 3% and for Non Critical circuits this is 10%. When the circuit is fully loaded (i.e. operating at rated amperage), the voltage of the appliance will be 3% or 10% below that at the battery. For example, if the battery is showing 12.6 Volts, the appliance will be seeing 12.2 Volts (3% loss), or 11.34 Volts (10% loss).

Some electrical loads (lights for example) will operate satisfactorily with a 10% voltage loss, but others are particularly sensitive to such losses (charging circuits and some electric motors). In general, given the harsh realities of the marine environment, it's advisable to use the 3% volt drop table when sizing cables. There is a performance penalty if the wire/cable is undersized but no such issues if it is marginally oversized.

The negative (ground) wire/cable must be the same size as the positive wire/cable

Wire size in Australia and Europe is generally indicated in mm<sup>2</sup> which displays the cross sectional area of the conductor. Most wire/cable that is used in d.c. applications will use the AWG (American Wire Gauge). There is a conversion chart AWG to mm<sup>2</sup>. Plans should display the wire size in mm<sup>2</sup>.

**Cable sizing selection chart:**

**Step 1. DC Amps**

Locate the current flow in amps of your circuit along the top of the chart (refer Figure 1 below).

**Step 2. Circuit Type**

Select the correct circuit type. Examples of Non Critical circuit are general lighting, windlasses, bait pumps, general appliances. Examples of Critical circuits are panel main feeders, bilge blowers, electronics, navigation lights.

**Step 3. Cable Length**

Find the correct cable length range. Please note that the cable length is total length of the positive and negative wires. i.e. Distance from battery to appliance multiplied by 2.

### Step 4. Correct Cable Size

Intersect the DC Amps with the cable length range to identify the correct coloured symbol.

Figure 1. Cable sizing selection chart

2. Circuit Type		1. DC Amps																
10% Voltage Drop Non Critical	3% Voltage Drop Critical	5A	10A	15A	20A	25A	30A	40A	50A	60A	70A	80A	90A	100A	120A	150A	200A	
0-6 m	0-2 m	●	●	●	●	●	●	●	●	●	●	●	●	●	●	●	●	●
6-9 m	2-3 m	●	●	●	●	●	●	●	●	●	●	●	●	●	●	●	●	●
9-15 m	3-4.5 m	●	●	●	●	●	●	●	●	●	●	●	●	●	●	●	●	●
15-19 m	4.5-6 m	●	●	●	●	●	●	●	●	●	●	●	●	●	●	●	●	●
19-24 m	6-7.5 m	●	●	●	●	●	●	●	●	●	●	●	●	●	●	●	●	●
24-30 m	7.5-9 m	●	●	●	●	●	●	●	●	●	●	●	●	●	●	●	●	●
30-40 m	9-12 m	●	●	●	●	●	●	●	●	●	●	●	●	●	●	●	●	●
40-51 m	12-15 m	●	●	●	●	●	●	●	●	●	●	●	●	●	●	●	●	●
51-61 m	15-18 m	●	●	●	●	●	●	●	●	●	●	●	●	●	●	●	●	●
	18-21 m	●	●	●	●	●	●	●	●	●	●	●	●	●	●	●	●	●
	21-24 m	●	●	●	●	●	●	●	●	●	●	●	●	●	●	●	●	●
	24-27 m	●	●	●	●	●	●	●	●	●	●	●	●	●	●	●	●	●
	27-30 m	●	●	●	●	●	●	●	●	●	●	●	●	●	●	●	●	●
	30-33 m	●	●	●	●	●	●	●	●	●	●	●	●	●	●	●	●	●
	33-37 m	●	●	●	●	●	●	●	●	●	●	●	●	●	●	●	●	●
	37-40 m	●	●	●	●	●	●	●	●	●	●	●	●	●	●	●	●	●

### Step 5. Cable Conversion Table

Match the correct coloured symbol from Step 4 using the chart (refer Figure 2 below) to find the cable size and specifications.













**IMPORTANT: Measurements of Diameter and Cross Section of cable does not include insulation. Cable Icons are for representational purposes only and are not to be taken as actual cable sizes.**

Note: Sometimes gauges are expressed as follows (e.g. 4/0 is the same as 0000). AWG stands for American Wire Gauges.

Note: Figure 2 refers to wire diameter and AWG to select wire sizes, Australia and New Zealand uses mm<sup>2</sup>.

The table above does not give accurate mm<sup>2</sup> conversions. The surveyor and electrician needs to be aware of this when assessing electrical systems on vessels. e.g. There is no 1.3 mm<sup>2</sup> cable distributed in Australia, the closest is 1.5 mm<sup>2</sup>. This issue is across all of the mm<sup>2</sup> sizes listed. Good electrical practice provides that the cable size chosen will be the larger size. If you choose the smaller size, you could possibly select a cable that will not meet the required voltage drop calculations.

**Figure 2. Cable conversion table**

Standard	Unit													
	0000	000	00	0	1	2	4	6	8	10	12	14	16	
AWG	0000	000	00	0	1	2	4	6	8	10	12	14	16	
Diameter (mm)	11.68	10.40	9.27	8.25	7.35	6.54	5.19	4.11	3.26	2.59	2.05	1.63	1.29	
Cross Section (mm <sup>2</sup> )	107.1	84.9	67.5	53.5	42.4	33.6	21.2	13.3	8.4	5.3	3.3	2.1	1.3	
Colour Code														

**Definition / explanation of active conductors:**

**NSCV Part C – Section 5 – Subsection 5B – Electrical  
3.7 Switches and Circuit protection**

The NSCV requires: In isolated systems, switches and circuit protection shall interrupt all active conductors i.e. double pole switches are to be used.

**Comment**

In implementing the requirement of the NSCV for double pole isolation, the standard does not define clearly the meaning of an active conductor. AMSA interprets an active conductor to be a conductor not at earth potential.

**AS/NZS 3000-2007 1.4.4 Active (or active conductor)**

Any conductor that is maintained at a difference of potential from the neutral or earthed conductor. In a system that does not include a neutral or earthed conductor, all conductors shall be considered to be active conductors.

Most modern engines of both inboard and outboard type have grounded negatives

In a negative earthed ELV system, single pole isolation of the positive battery terminal is accepted.

For both above earth and negative earthed systems, the positive active circuit is to be protected by an appropriate rated circuit breaker.

**Vessel application**

Double pole isolation of conductors is required in ELV above earth systems

Single pole isolation of the positive active conductor is required in negative earthed ELV systems.

An appropriately rated circuit breaker or fuse is to be provided on the active positive conductor for both above earth and negative earthed systems.

**Into the future:**

As technology improves the number of electric powered vessels will increase. Designers of these vessels will need to carefully consider safe and adequate battery storage areas in their design.

**Common issues  
(what to look for):**

**Figure 3.** Inadequate protection of cables/wiring when passing through structures. Cables/wiring penetrations shall not impair the effectiveness of fire protection and water tightness.

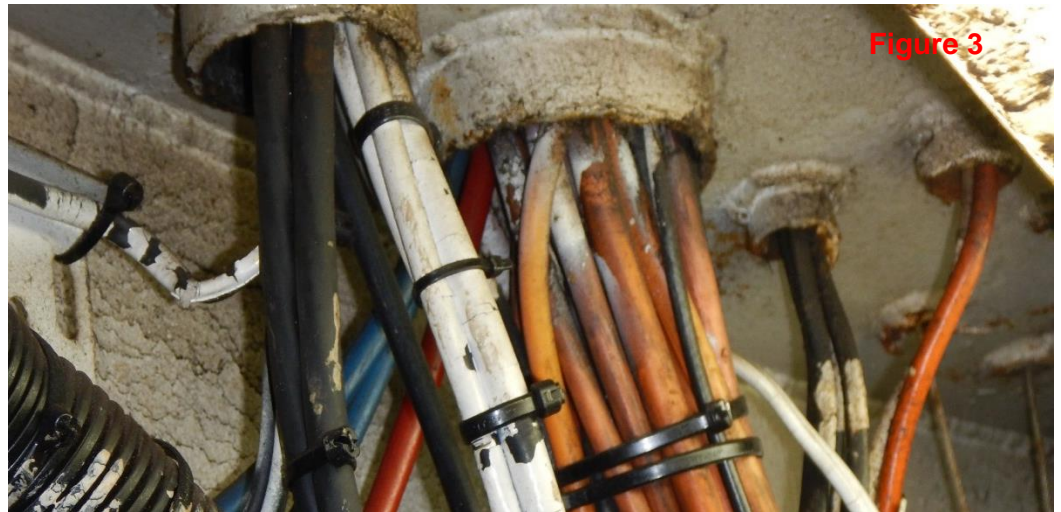

**Figure 3**

**Figure 4.** Battery installation not suitable. There are no covers over the battery terminals, battery not secured against movement in all directions. The use of wing nuts is not recommended. Positive (red) cable is not adequately secured and does not have adequate mechanical protection.



**Figure 4.**

**Figure 5.** The use of uncovered terminal strips and fuse boards is not recommended.

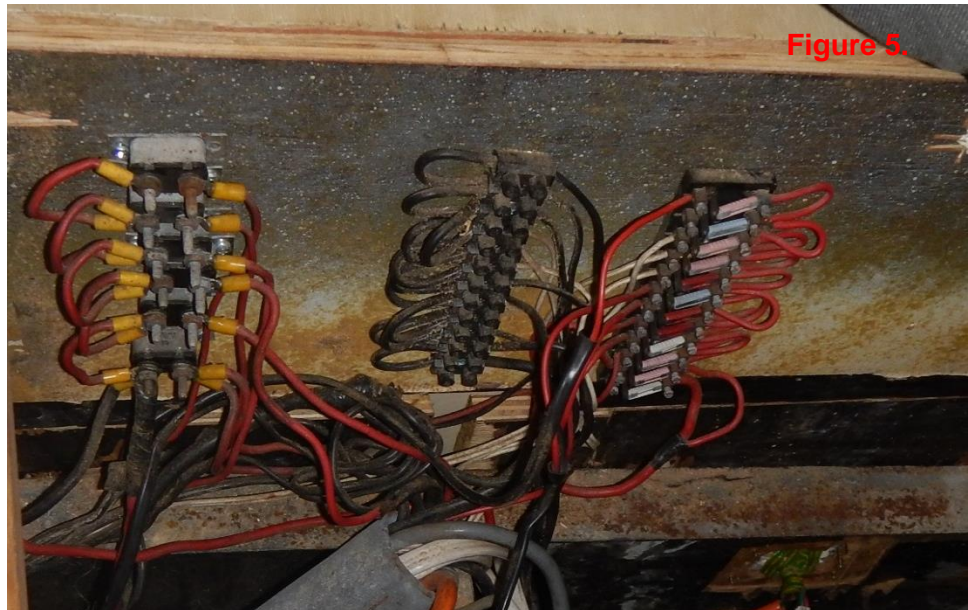

**Figure 6.** Batteries are to be in a location away from sources of ignition. Battery box is not sealed and is not vented outside.



Figure 7. The use of switch gear in close proximity to batteries.



Figure 7.

Figure 8. Battery inadequately secured.



Figure 8.

**Figure 9.** Batteries and wiring not meeting the requirements in the standards. There are no terminal covers on the terminals. The batteries are not secured and the wiring is not supported.

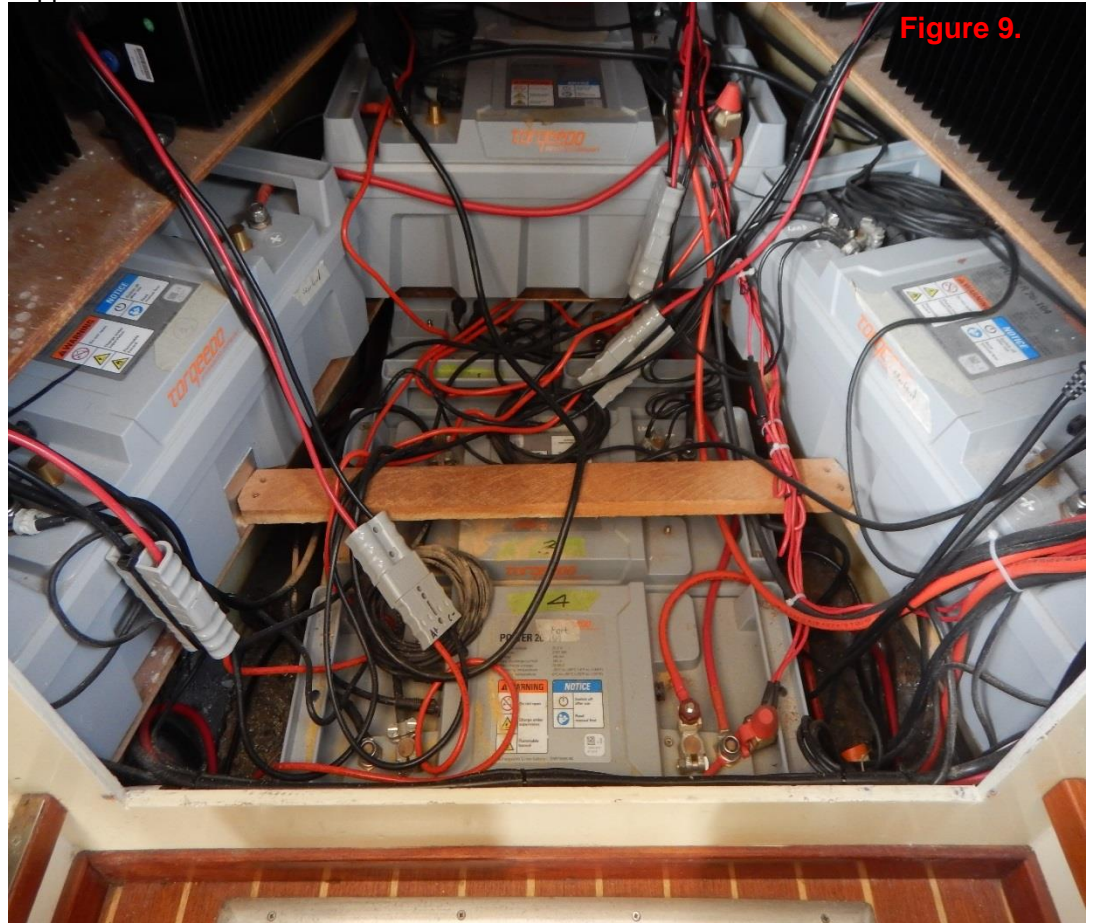

**Figure 9.**

**Figures 10, 11 and 12** depict what happens when a battery explodes. Acid would have been atomised and sprayed throughout the compartment. This acid causes damage to the surroundings and could have caused serious injuries to the crew.





Figure 10.



Figure 11.



Figure 12.



**Examples of good battery installations:**

**Figure 13.** Batteries in this installation are separate from the switchgear. Wiring is routed through the panel via watertight/gastight glands. The door has ventilation. All components are labelled.



# EXAMPLE OF A BASIC BOAT ELV ELECTRICAL INSTALLATION

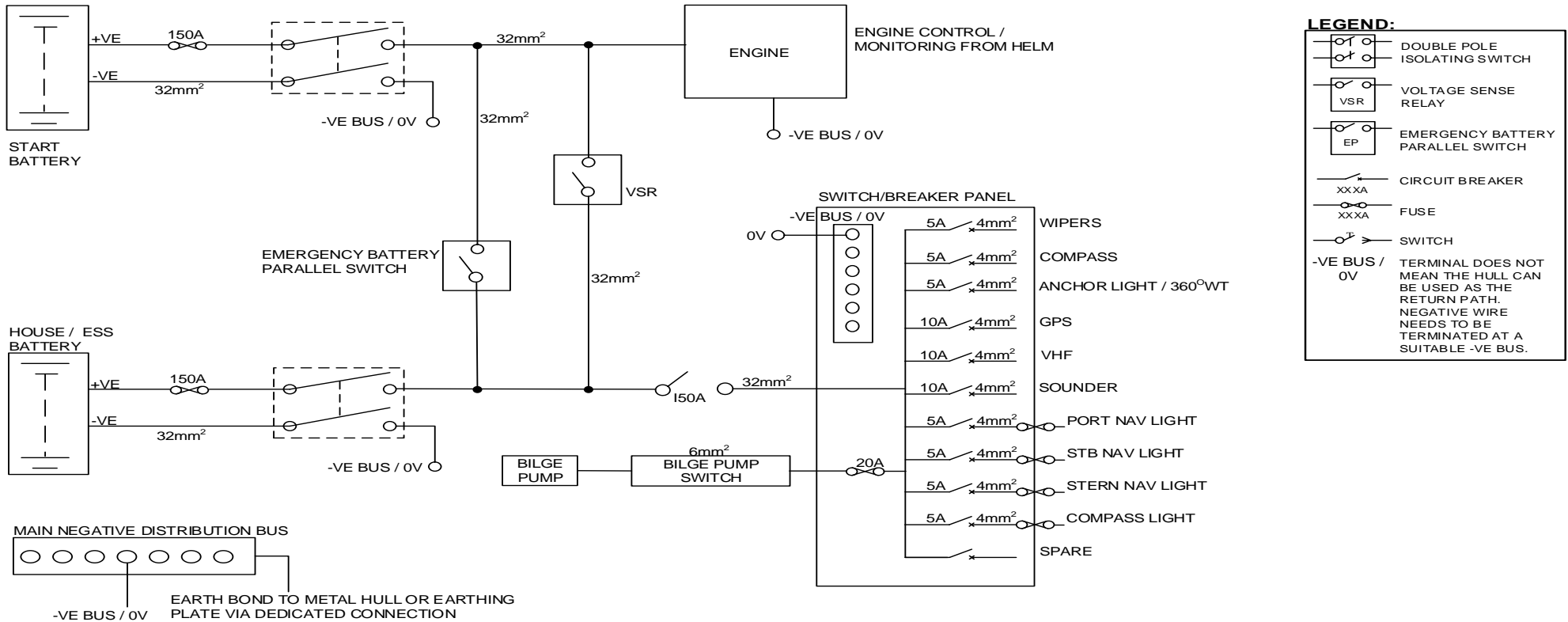

## REGULATIONS:

- Wiring to be installed in accordance with the NSCV Part C Subsection 5B
- Wiring also has to comply with AS/NZS 3000:2007
- Marine Order Part 30. Prevention of Collisions
- Negative cables to terminate at -VE Bus – Hull not to be used as return
- Wiring shall be stranded wire in accordance with NSCV 5B 2.15.2 (with the exception of MIMS)
- Cable size and protection devices to comply with equipment manufacturers recommendations
- Cable sizes shown are for guidance only – ref to AS /NZN 3000 for voltage drop calculations
- Carry out interruption current calculations for main isolating switch and main battery over current protection
- Battery Voltage, Amp Hours and type need to be stated

Contact: [DCVSurvey@amsa.gov.au](mailto:DCVSurvey@amsa.gov.au)